

HLSA12,5-600/2+0

- Lightning impulse current and surge arresters type T1+T2 ensure the equipotential bonding, eliminate the effects of lightning current and reduce switching, induced and residual overvoltage in single-phase and three-phase power supply systems.
- Suitable for objects with considerable levels of protection LPL III and LPL IV, such as small administration complexes, residential buildings, family houses or properties and halls without the incidence of persons and indoor equipment.
- Installed at the boundaries of LPZ 0 – LPZ 1 and higher zones, closest to where overhead line enters the building i.e. in the main distribution boards.
- The products consist of varistors with big discharge ability.
- Configurations 1+1 and 3+1 are additionally combined with a gas discharge tube which ensures zero leakage current through the PE conductor.
- If the product contains two PE (or PEN) terminals, it must not be used as a PE (PEN) bridge.
- **S** indication specifies a version with remote monitoring.

Type	HLSA12,5-600/2+0	
Test class according to EN 61643-11:2012 (IEC 61643-11:2011)	T1, T2	
System	TN-S	
Number of poles	2	
Rated operating AC voltage	U_N	500 V
Maximum continuous operating voltage AC	U_C	600 V
Maximum discharge current (8/20)	I_{max}	50 kA
Impulse discharge current for class I test (10/350)	I_{imp}	12.5 kA
Charge	Q	6.25 As
Specific energy for class I test	W/R	39 kJ/Ω
Total discharge current (10/350) L+N->PE	I_{Total}	25 kA
Total discharge current (8/20) L+N->PE	I_{Total}	100 kA
Nominal discharge current for class II test (8/20)	I_n	20 kA
Open circuit voltage of the combination wave generator	U_{OC}	6 kV
Voltage protection level at I_n	U_p	< 2.4 kV
Temporary overvoltage test (TOV) for $t_T = 5$ s	U_T	726 V
Response time	t_A	< 25 ns
Maximal back-up fuse	160 A gL/gG	
Short-circuit current rating at maximum back-up fuse	I_{SCCR}	60 kA _{rms}
Lightning protection zone	LPZ 0-1, LPZ 1-2, LPZ 2-3	
Housing material	Polyamid PA6, UL94 V-0	
Degree of protection	IP20	
Operating temperature	θ	-40 ÷ 70 °C
Minimum cross-section of connected Cu conductors accord. to HD 60364-5-53:2022 (doesn't apply to „V“ connection) for T1	S	6 mm ² (L, N) 16 mm ² (PE, PEN)
Minimum cross-section of connected Cu conductors accord. to HD 60364-5-53:2022 (doesn't apply to „V“ connection) for T2	S	2.5 mm ² (L, N) 6 mm ² (PE, PEN)
Clamp fastening range (solid conductor)	1.5 ÷ 25 mm ²	

Type	HLSA12,5-600/2+0	
Clamp fastening range (stranded conductor)	1.5 ÷ 16 mm ²	
Tightening moment	3 Nm	
Installation	On DIN rail 35 mm	
Modular width	4 TE	
Operating position	Any	
Signalling at the device	Optic	
Importance of local signaling	OK – clear target FAULT – red target	
Remote signalling	No	
Modular design	No	
Lifetime	> 100 000 h	
Designed according to standards		
Requirements and test methods for SPDs connected to low-voltage power systems	IEC 61643-11:2011	
Safety of Flammability of Plastic Materials	UL 94	
Application standards		
Protection against lightning	IEC 62305:2010	
Selection and erection of electrical equipment – Switchgear and controlgear	HD 60364-5-53:2022	
Selection and application principles for SPDs connected to low-voltage power systems	CLC/TS 61643-12:2009	
Ordering, packaging and additional data		
Mass	m	660 g
Mass (including the packaging)	m	688 g
Packaging dimensions (H x W x D)	74 x 112 x 73 mm	
Packaging value	V	0.61 dm ³
ETIM group	EG000021	
ETIM class	EC001457	
Customs tariff no.	85363010	
EAN code	8590681113936	
Art. number	10 347	



The link in the QR code leads to the online presentation of the **HLSA12,5-600/2+0**. There, in addition to the always up-to-date data sheet, you will also find all diagrams and drawings, declarations of conformity, or 2D or 3D models and other necessary materials. For more information, visit www.hakil.com



Application wiring diagram (installation)

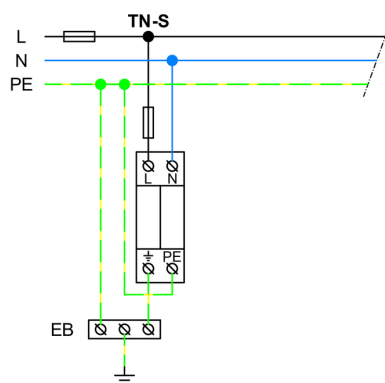

Internal diagram

